



# DATA SHEET

**new SOLAR®**  
European Patent EP-3184726B1  
a product by Tenda System Italia

mini



**Total weight per square meter** 8 kg

**Maximum recommended dimensions** 170 cm x 300 cm  
width x height

**PACKAGE CONTENTS:**

- Complete roller shutter curtain
- Safety springs for roller attachment with cover
- Rail brush

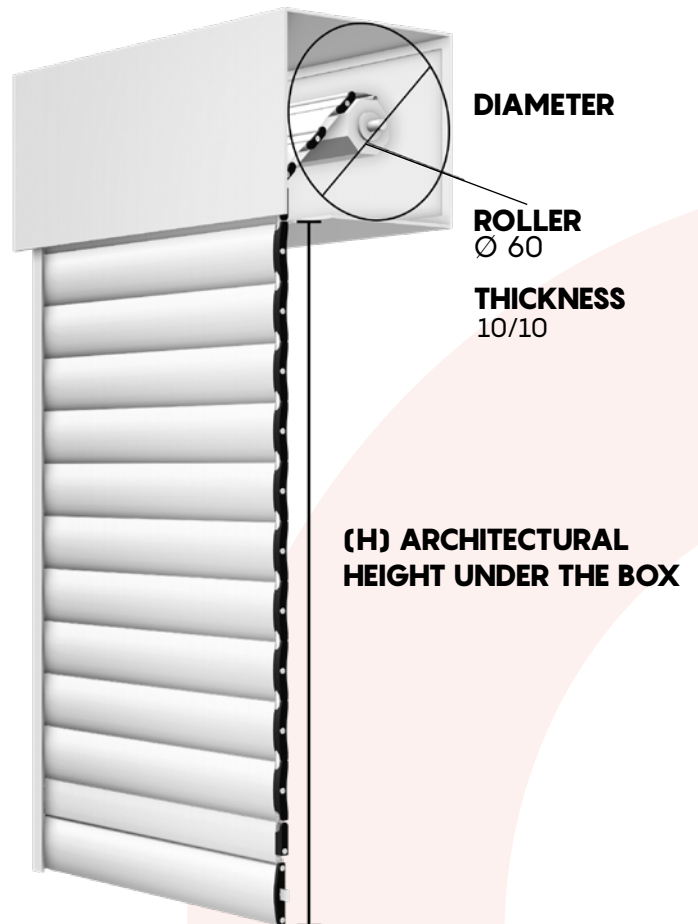

**AVAILABLE DISTANCES BETWEEN THE ROLLER SHUTTER CURTAIN SLATS: 1**

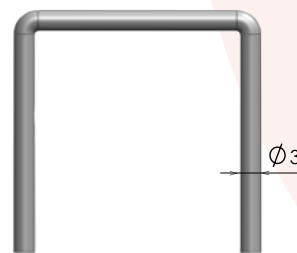
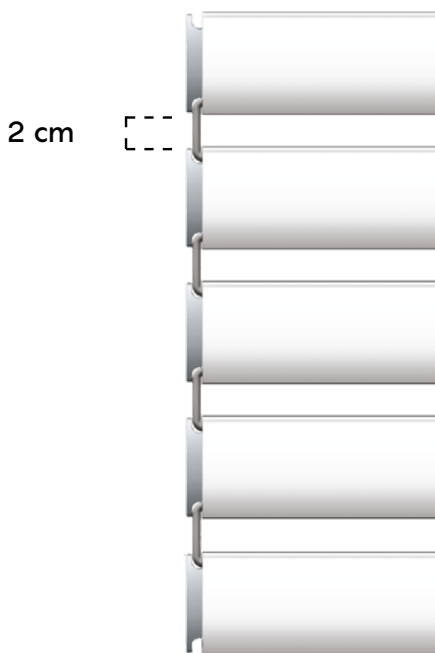

**HOOKS new Solar<sup>®</sup> mini 2 cm**

**The distance between one slat and the other can have a variation of up to 3 mm**

## OVERALL DIMENSIONS TABLE

SPACER HOOKS 2 cm

### UP TO 130 CM WIDTH ROLLER SHUTTER CURTAIN

FINISHED HEIGHT	DIAMETER
120	14,4
140	15,0
160	16,5
180	16,8
200	17,4
220	18,3
240	19,0
260	19,6
280	20,3
300	21,4

### UP TO 170 CM WIDTH ROLLER SHUTTER CURTAIN

FINISHED HEIGHT	DIAMETER
120	14,6
140	15,9
160	16,8
180	16,9
200	17,8
220	18,5
240	19,5
260	20,0
280	20,5
300	21,7



**mini regular 2 cm**

galvanized steel FE37 cod. **SOL2MTSG**  
stainless steel cod. **SOL2MTSGI**

**EXTRUDED ALUMINUM PROFILES**

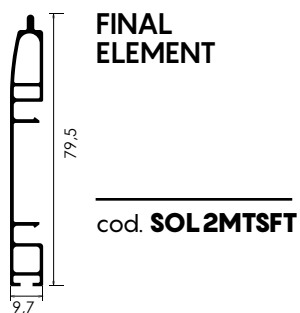
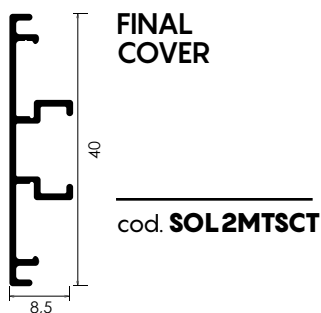
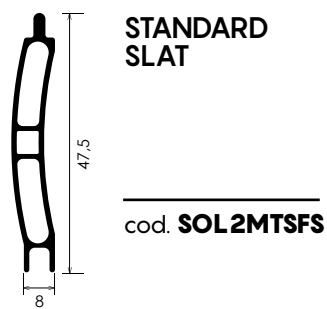
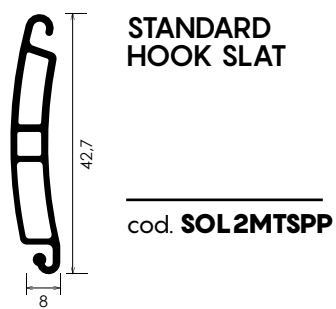
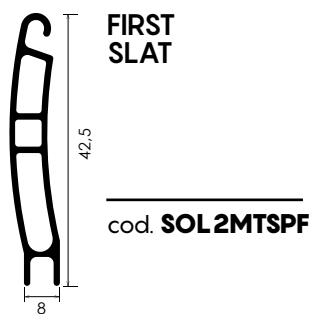

**CAPS**



**STANDARD CAP**  
 cod. **SOL2MTSTS**



**FINAL CAP (PAIR)**  
 cod. **SOL2MTSTT**



**SAFETY FINAL CAP (PAIR)**  
 cod. **SOL2MTPF**



**ROLLER HOOKING SLAT CAP**  
 cod. **SOL2MTSFAR**

**CLOSURES**



**FINAL CLOSURE BOLT**  
 cod. **SOL2TSCI**

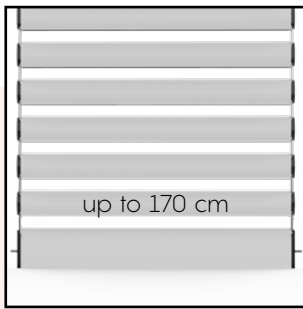

## MAXIMUM DIMENSIONS

This new Solar® model is available with a maximum width of 170 cm per single roller shutter curtain.



## VERY REDUCED DIMENSIONS

New Solar® model with the smallest overall dimensions of the whole range. Suitable also for external boxes.



## LOCK ON TERMINAL SLAT

This new Solar® model can only be closed with a stop on the end slat.



## REGULAR SYSTEM

Patented feature that turns the new Solar® into a sunscreen. The Silent variant is not available for this model as its movement is already silent.

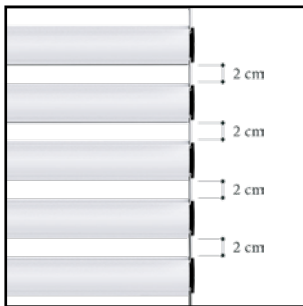

## UNIQUE DISTANCE

The roller shutter curtain of this new Solar® can be ordered with a single 2 cm spacer. In perfect harmony with the size of its slats.

## HOW TO TAKE MEASUREMENTS

**ROLLER SHUTTER CURTAIN WIDTH:** measure the width by referring to the inside of the rails and report the measurement after subtraction of -7 mm.

**EXAMPLE:** In case of real dimension 92,7 cm, you need to communicate 92 cm at the order placement

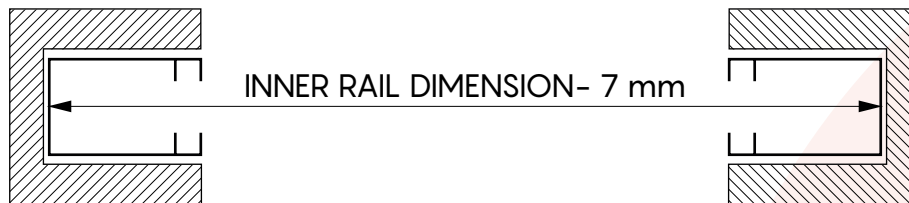

**ROLLER SHUTTER CURTAIN HEIGHT:** measure the height referring to the ARCHITECTURAL LIGHT and report the measurement after addition of +10 cm.

**EXAMPLE:** in case of exact dimension 210 cm, you need to communicate 220 cm at the order placement  
For BT > 5 cm add 1 cm to the finished dimension for each additional cm

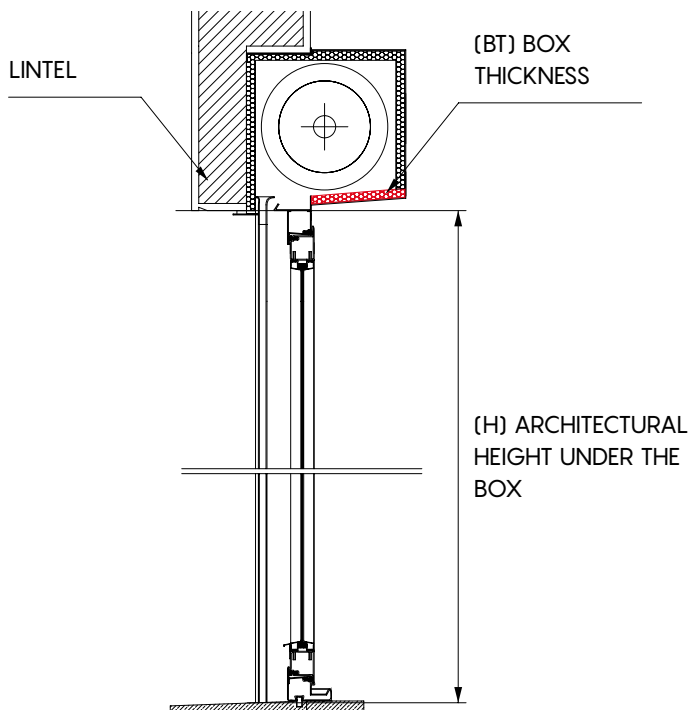

To calculate the finished height, add 10 cm up to a BT of 5 cm ( $H + 10$  cm) to the dimension of the architectural height under the box H.

For box thickness BT over 5 cm, add 1 cm to the final dimension for each additional cm.

E.g.: box thickness BT 6 cm =  $H + 11$  cm

E.g.: box thickness BT 8 cm =  $H + 13$  cm

Example:

H = 210 cm dimension to be communicated 220 cm

Example:

BT 6 cm dimension to be communicated 221 cm

Example:

BT 7 cm dimension to be communicated 222 cm

### WARNING

At the order placement it is necessary to communicate only final dimensions:

inner rail WIDTH -7mm

light HEIGHT + 10 cm if BT > 5 cm then add 1 cm to the final dimension for each additional cm

**WARNING:** the SILENT function is not currently provided for this model.

## OPTIONS FOR CURTAIN CLOSING

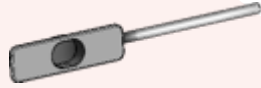

final bolt

## COMPATIBLE RAILS

The rails have always the same height as the final dimension of the roller shutter curtain

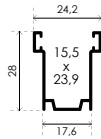

### GATS 001N

Required brush:  
up to width 100 cm bristle height 0,5  
over 100 cm bristle height 0,7

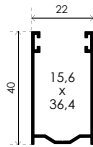

### GATS 006N

Required brush:  
up to width 100 cm bristle height 0,5  
over 100 cm bristle height 0,7

**Warning:** for regular operation of the **newsolar**<sup>®</sup> it is necessary to use only the brush supplied with the configured and ordered rail, which is included in the package already cut at the required dimension.